

Data Sheet



Article number: 20990ALD35500EL

Description: E+G GN 990 Construction tube round
GN 990-AL-D35-500-EL

Measures

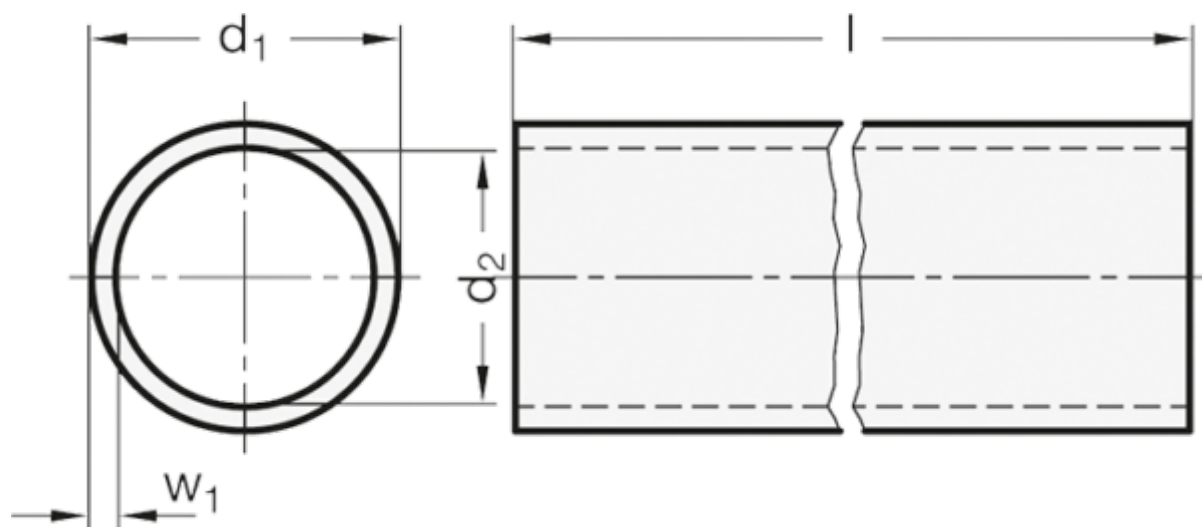

d_1 = D35 \pm 0.15

d_2 = 31

$l \pm 0.5$ = 500

w_1 = 2

Weight in (g) = 281